

# Contents

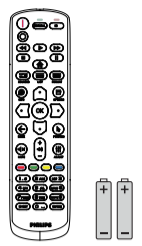

Power Cord



Display Port Cable

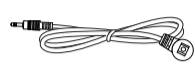

IR Sensor Cable

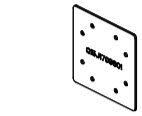

Edge Alignment Kit-1

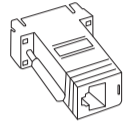

DB9(female) to RJ12/45 adaptor



RJ45 cable for daisy chain



Edge Alignment Pin X 2 PCS



Edge Alignment Kit-2 X 2 PCS



Gap Mylar X 3 PCS

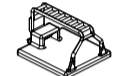

Wire Clamper X 3 PCS

\* Differences according to regions.  
Display design and accessories may differ from those illustrated above.

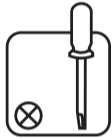

1

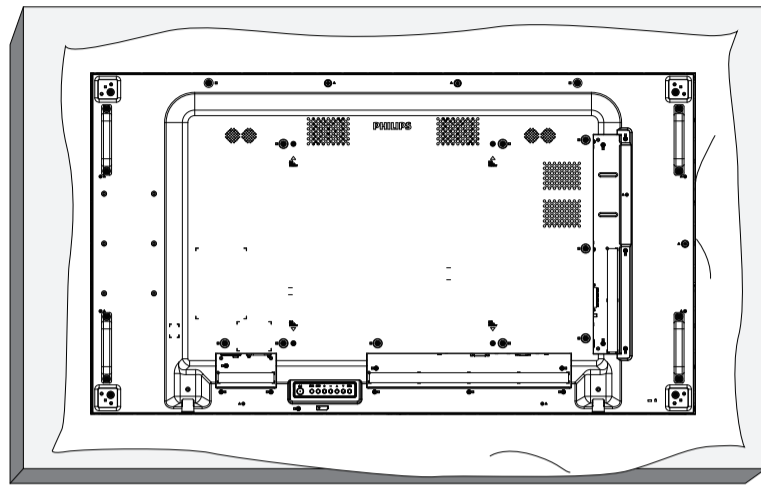

2

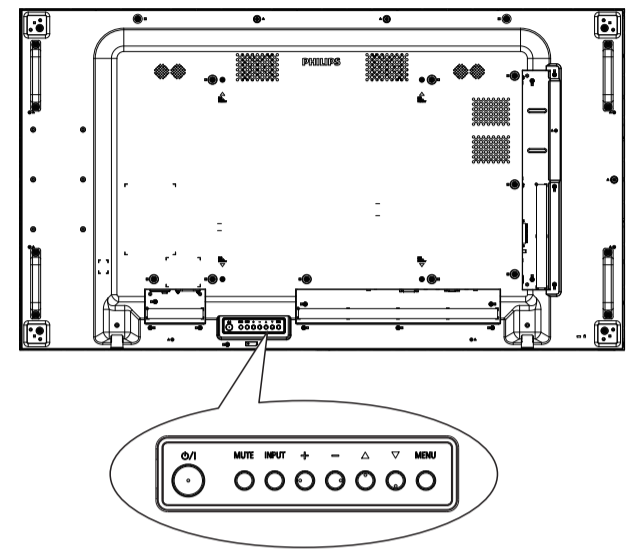

3

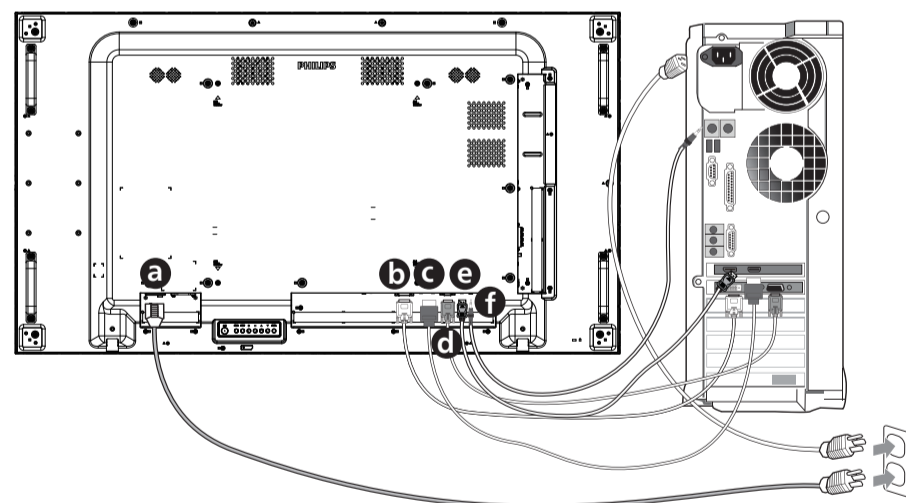
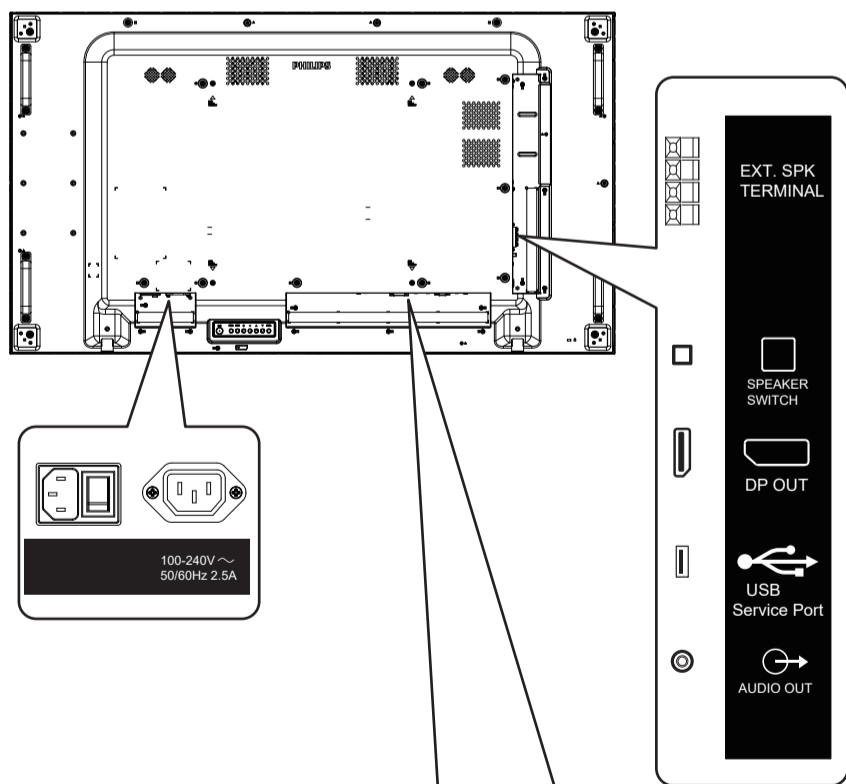

AC IN

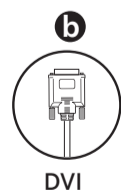

DVI

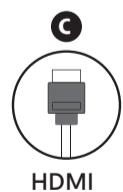

HDMI

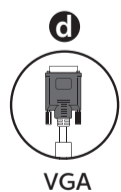

VGA



DP



AUDIO

4

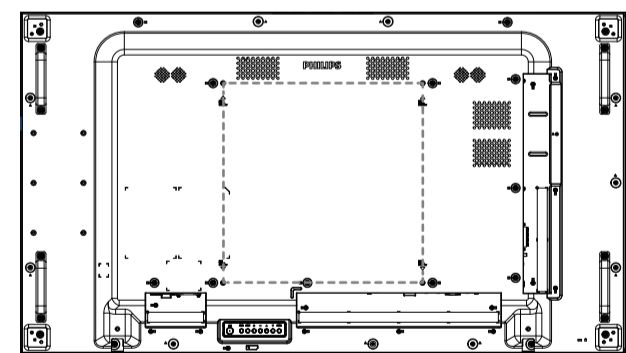

M6 \* (10+X) mm  
(X=Thickness of Wall mount BKT)  
55BDL3207X: 400mm x 400mm

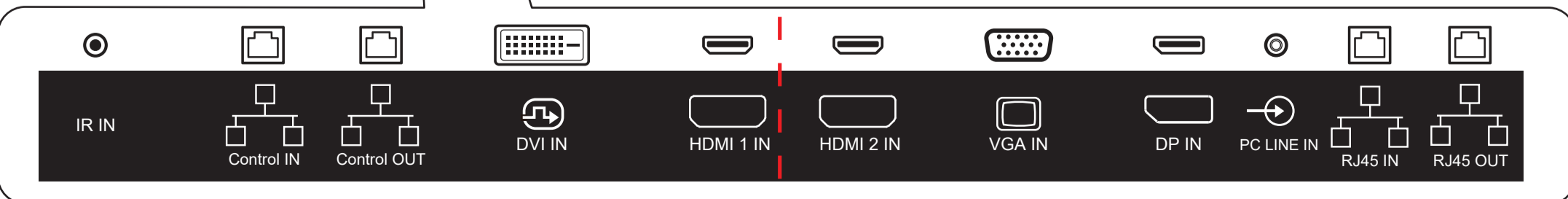

5

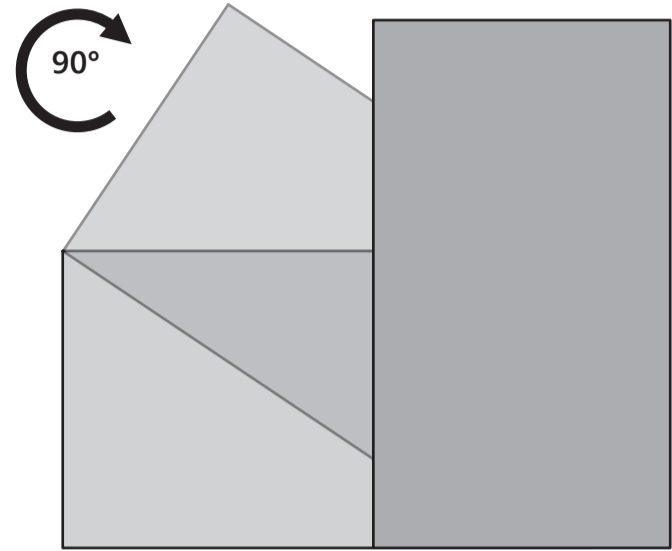

**PHILIPS**  
Professional  
Display Solutions  
X Line  
55BDL3207X

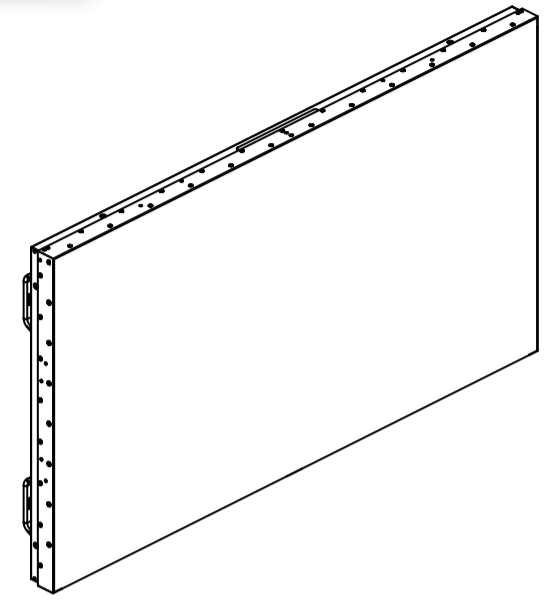

# Quick start



For more information, please visit:  
[www.philips.com/signagesolutions-support](http://www.philips.com/signagesolutions-support)



Version: V1.01 2022-03-04

Envision Peripherals Inc.  
490 N McCarthy Blvd, Suite #120  
Milpitas, CA 95035  
USA

2022 © TOP Victory Investments Ltd. All rights reserved.

This product has been manufactured by and is sold under the responsibility of Top Victory Investments Ltd., and Top Victory Investments Ltd. is the warrantor in relation to this product. Philips and the Philips Shield Emblem are registered trademarks of Koninklijke Philips N.V. and are used under license.

Specifications are subject to change without notice.

